



Ecophon Hygiene Performance™ Ds

Ecophon Hygiene Performance™ Ds is a suspended ceiling with a concealed grid, where individual tiles must be easily demountable. Suitable for swimming pool areas, it's compatible in areas with high humidity, corrosivity and occasional direct water.



SYSTEM RANGE

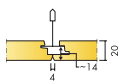

Size, mm	600x600	1200x600
T24	•	•
Thickness	20	20
Inst. Diagr.	M616C4	M616C4

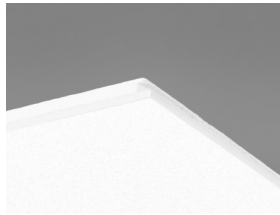

Performance Ds tile

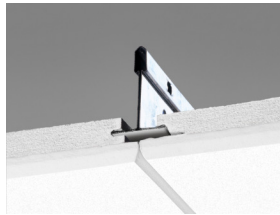

Section of Performance Ds system with Connect T24 Main Runner C4

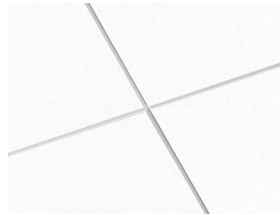

Performance Ds system



The individual tiles are easily demountable

Acoustic



Sound Absorption:

Test results according to EN ISO 354. Classification according to EN ISO 11654, and the single value ratings for Noise Reduction Coefficient, NRC and Sound Absorption Average, SAA according to ASTM C 423.

α_p , Practical sound absorption coefficient

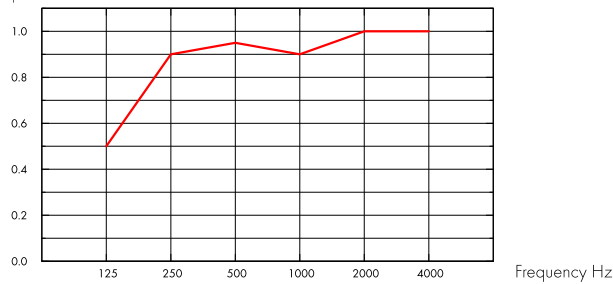

— Hygiene Performance Ds 20 mm, 200 mm o.d.s.

o.d.s = overall depth of system

THK mm	o.d.s. mm	α_p , Practical sound absorption coefficient						α_w	Sound absorption class
		125 Hz	250 Hz	500 Hz	1000 Hz	2000 Hz	4000 Hz		
20	200	0.50	0.90	0.95	0.90	1.00	1.00	0.95	A

THK mm	o.d.s. mm	NRC	SAA
20	200	0.95	0.95

Indoor Air Quality



Certificate / Label	
Eurofins Indoor Air Comfort®	IAC Gold
French VOC	A+
Finnish M1	•



Carbon footprint



	kg CO ₂ equiv/m ²
Hygiene Performance Ds (EN 15804+A2)	3,5

Life-cycle stages A1 to C4 from EPD, in conformity with ISO 14025 / EN 15804

Circularity



Minimum post-consumer recycled content	51%
Recyclability	Fully recyclable



Fire safety

Country	Fire standard	Class
Europe	EN 13501-1	A2-s1,d0

The glass wool core of the tiles is tested and classified as non-combustible according to EN ISO 1182.



Humidity Resistance

Class C, relative humidity 95% and 30°C, according to EN 13964:2014



Visual appearance

White 500, nearest NCS colour sample S 0500-N, 84% light reflectance.



Cleanability

Daily dusting and vacuum cleaning. Weekly wet wiping.



Advanced Cleanability

Steam cleaning. Can withstand use of hydrogen peroxide vapour.



Surface Endurance

Product tested according to ISO 11998, and withstand 200 cycles.



Chemical resistance/Disinfection

Chemical	Active Substance	Concentration
Actichlor plus	NaDCC (Sodium Dichloroisocyanurate)	1%
LifeClean	Chlorine dioxide	Undiluted
Ethanol	Ethanol	70%
Chlorine	Sodium Hypochlorite solution	2,5%
Virkon S	Dipotassium peroxodisulphate; Sulphamic acid	1%
Isopropanol	Isopropyl Alcohol	70%
Oxivir Excel	Hydrogen peroxide	0,5%
Sumabac D10	Quaternary ammonium compound, Sodium carbonate	1%
Suredis VT1	n-(3-aminopropyl)-n-dodecylpropan-1,3-diamin	1%
Enduro Chlor VE5	Potassium hydroxide	1,5%
Acipusfoam VF59	Nitric Acid	5%

Tested according to ISO 11998 and withstand the following chemicals or disinfectants.



Mould and Bacterial Resistance

Standard/Method	
ISO 846 :2019 method C (for bacterium)	0 (No growth under the microscope)
ASTM D3273-16 (for fungi)	10 (0% growth on the surface)



Clean Room

Standard/Method		Class
ISO 14644	Particle cleanliness class	ISO 4
NF S 90-351	Microbiological class	M1/area 4
NF S 90-351	Particle elimination kinetics	CP(0,5) 5



Accessibility

The tiles are demountable.



Installation

Installed according to installation diagrams, installation guides and drawing aid. Cut panels must be sealed with Connect Edge sealant. Penetrations must be sealed with a suitable sealant.



System weight

		kg/m ²	Weight information is indicative and subject to variation.
Hygiene Performance Ds		2,5	
Hygiene Performance Ds + Connect grid system		3,4	



Mechanical properties

See table about Max live load and Min load bearing capacity and Functional demands, Mechanical properties at www.ecophon.com.



CE

Ecophon ceiling systems are CE marked according to the European harmonized standard EN13964:2014. CE marked construction products are covered by a Declaration of Performance (DOP) which enables customers and users to easily compare performance of products available on the European market.

INSTALLATION DIAGRAM (M616C4) FOR ECOPHON PERFORMANCE™ DS C4. SUSPENDED INSTALLATION

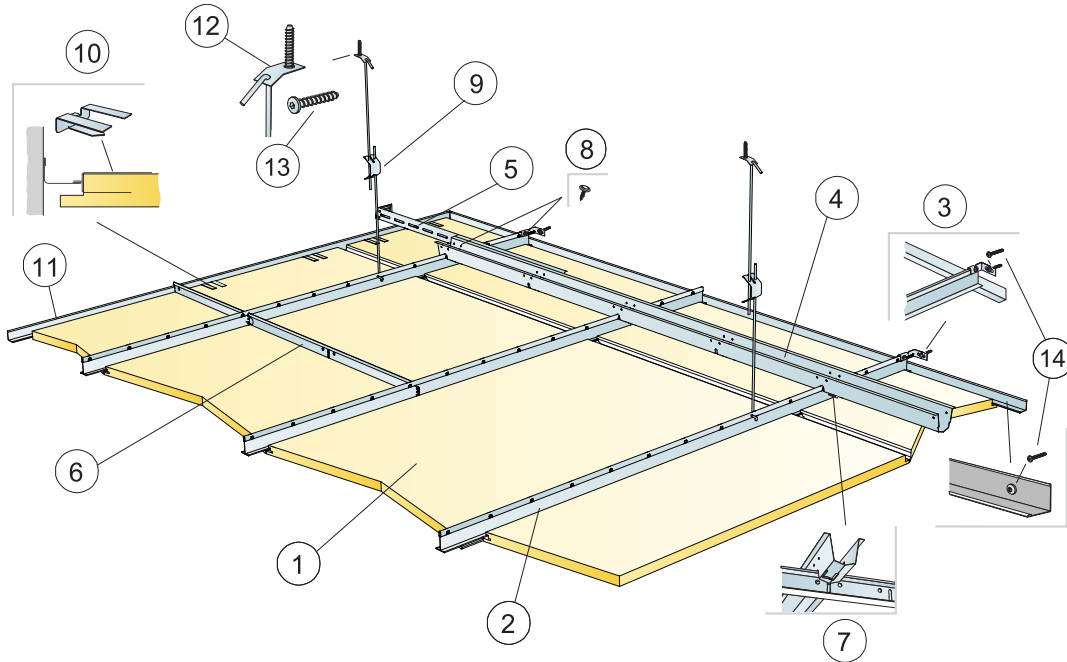

© Saint-Gobain Ecophon AB

QUANTITY SPECIFICATION (EXCL. WASTAGE)

	Size, mm	
	600x600	1200x600
1 Hygiene Performance Ds	2,8/m ²	1,4/m ²
2 Connect T24 Main Runner C4, installed at 600 mm centres	1,7m/m ²	1,7m/m ²
3 Connect Wall Bracket C4 for T-profiles C4	1/suspended row of Main runner	
4 Connect Space Bar C4, installed at 1500 mm centres (max. distance from wall 300 mm) for winch	0,7m/m ²	0,7m/m ²
5 Connect Wall Bracket C4, l=700 mm, for Connect Space Bar	1/row of Space bar	
6 Connect T24 Cross Tee C4, l=600 mm	2/row of Main runner	
7 Connect Space Bar Winch C4, installed one per joint Connect Main Runner/Space Bar	1,4/m ²	1,4/m ²
8 C4 screw for wall brackets(included in products)	-	-
9 Connect Adjustable Hanger C4, installed at 1200 mm centres (max. distance from wall 600 mm)	0,7/m ²	0,7/m ²
10 Connect Support Clip Dg20 C4	1pc/300-400 mm on every cut perimeter tile with only 1 supporting edge	
11 Connect Angle Trim 15/22 C4, fixed at 300 mm centres	as required	as required
12 Connect Fixing Plate C4	0,7/m ²	0,7/m ²
13 Connect Anchor Screw C4	0,7/m ²	0,7/m ²
14 Connect Installation Screw C4	3,4/lm Channel trim C4	
Δ Min. overall depth of system: 385 mm	-	-
δ Min. demounting depth: 30 mm	-	-

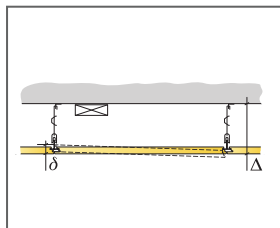

See Quantity Specification

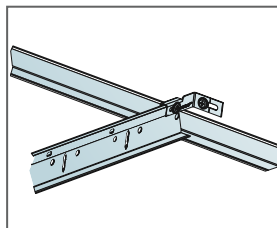

Secured Connect Main Runner C4 at wall with Connect Wall Bracket C4

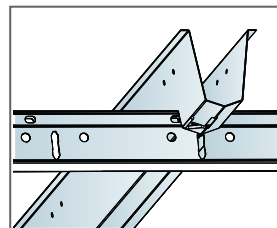

Size, mm	Max live load [N]	Min load bearing capacity [N]
600x600x20	40	160
1200x600x20	40	160

Live load/load bearing capacity