



Ecophon Hygiene Meditec™

A

Ecophon Hygiene Meditec™ A has an exposed grid, suitable for dry areas where disinfection and/or cleaning is required on a regular basis. The surface is resistant to mould and bacteria growth and common detergents and disinfectants. The absorbers have low emission levels, ensuring high indoor air quality.



Spain

SYSTEM RANGE

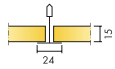

Size, mm	600x600	1200x600
T24	•	•
Thickness	15	15
Inst. Diagr.	M255	M255

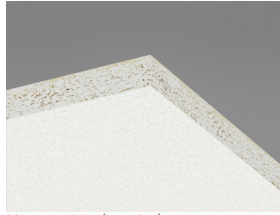

Hygiene Meditec A tile



Hygiene Meditec A C1 section with Connect Universal clip



Hygiene Meditec A C1 system

Acoustic



Sound Absorption:

Test results according to EN ISO 354. Classification according to EN ISO 11654.

α_p , Practical sound absorption coefficient

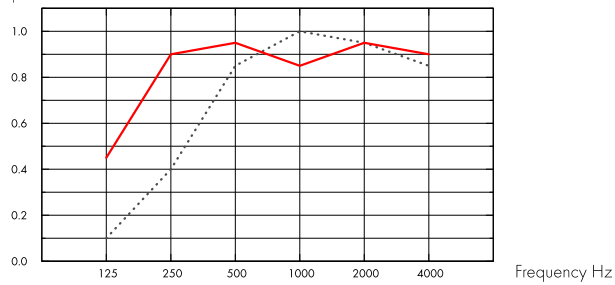

... Hygiene Meditec A 15 mm, 50 mm o.d.s.
 — Hygiene Meditec A 15 mm, 200 mm o.d.s.
 o.d.s = overall depth of system

THK mm	o.d.s. mm	α_p , Practical sound absorption coefficient						α_w	Sound absorption class
		125 Hz	250 Hz	500 Hz	1000 Hz	2000 Hz	4000 Hz		
15	50	0.10	0.40	0.85	1.00	0.95	0.85	0.70	C
15	200	0.45	0.90	0.95	0.85	0.95	0.90	0.95	A

THK mm	o.d.s. mm	NRC	SAA
15	50	0.80	0.83
15	400	0.85	0.89

Indoor Air Quality



Certificate / Label	All Products
Eurofins Indoor Air Comfort®	IAC Gold
French VOC	A+
Finnish M1	•



Cradle to Cradle Certified®



This product is Cradle to Cradle Certified® at Bronze level (version 4.0).



Material Health

This product has received a C2C Certified Material Health Certificate™ at the Silver level (standard version 4.0). The C2C Certified Material Health Certificate™ is a verification of the health and safety of a product's composition using the Material Health requirements of the Cradle-to-Cradle Certified Product Standard.



Carbon footprint

	kg CO ₂ equiv/m ²	Life-cycle stages A1 to C4 from EPD, in conformity with ISO 14025 / EN 15804
Hygiene Meditec A	2,71	



Circularity

Minimum post-consumer recycled content	44%
Recyclability	Fully recyclable



Fire safety

Country	Fire standard	Class	The glass wool core of the tiles is tested and classified as non-combustible according to EN ISO 1182.
Europe	EN 13501-1	A2-s1,d0	



Humidity Resistance

Class C, relative humidity 95% and 30°C, according to EN 13964:2014



Visual appearance

White 500, nearest NCS colour sample S 0500-N, 84% light reflectance.



Cleanability

Daily dusting and vacuum cleaning. Weekly wet wiping.



Advanced Cleanability

Can withstand use of hydrogen peroxide vapour. Occasional steam cleaning (1/year).



Surface Endurance

Product tested according to ISO 11998, and withstand 200 cycles.



Chemical resistance/Disinfection

Chemical	Active Substance	Concentration	Tested according to ISO 11998 and withstand the following chemicals or disinfectants.
Ethanol	Ethanol	70%	
Chlorine	Sodium Hypochlorite solution	2,5%	
Virkon S	Dipotassium peroxodisulphate; Sulphamic acid	1%	
Isopropanol	Isopropyl Alcohol	70%	



Mould and Bacterial Resistance

Standard/Method	
ISO 846 :2019 method C (for bacterium)	0 (No growth under the microscope)
ASTM D3273-16 (for fungi)	10 (0% growth on the surface)



Clean Room

Standard/Method		Class
ISO 14644	Particle cleanliness class	ISO 4
NF S 90-351	Microbiological class	M1/area 4
NF S 90-351	Particle elimination kinetics	CP(0,5) 5



Accessibility

The tiles are demountable. Minimum demounting depth according to installation diagram. The tiles are secured using Hygiene Clip 20 to allow for effective in-situ cleaning. The clips are easily removable from above the ceiling. A tightly sealed, easy-to-open Hygiene Inspection hatch is available to simplify access to the ceiling void.



Installation

Installed according to installation diagrams, installation guides and drawing aid. Cut panels must be sealed with Connect Edge sealant. Penetrations must be sealed with a suitable sealant.



Mechanical properties

See table about Max live load and Min load bearing capacity and Functional demands, Mechanical properties at www.ecophon.com.



System weight

	kg/m ²	Weight information is indicative and subject to variation.
Hygiene Meditec A	1,3	
Hygiene Meditec A + Connect grid system	2,3	



CE

Ecophon ceiling systems are CE marked according to the European harmonized standard EN13964:2014. CE marked construction products are covered by a Declaration of Performance (DOP) which enables customers and users to easily compare performance of products available on the European market.

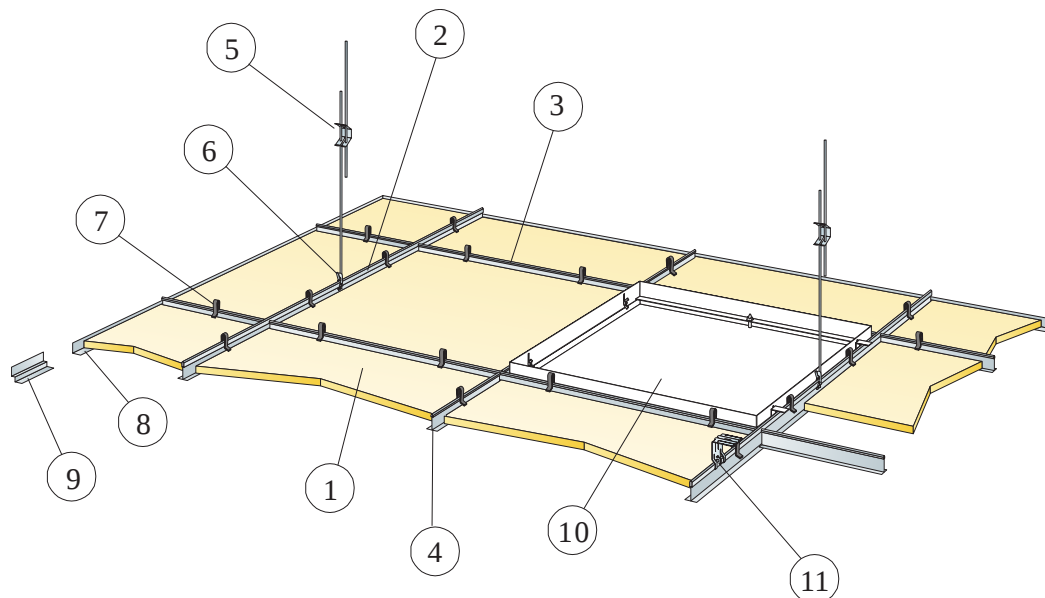

© Saint-Gobain Ecophon AB

QUANTITY SPECIFICATION (EXCL. WASTAGE)

	Size, mm	
	600x600	1200x600
1 Hygiene Meditec A	2,8/m ²	1,4/m ²
2 Connect T24 Main Runner, installed at 1200 mm centres (max distance from wall 300 mm)	0,9m/m ²	0,9m/m ²
3 Connect T24 Cross Tee, L=1200 mm, installed at 600 mm centres	1,7m/m ²	1,7m/m ²
4 Connect T24 Cross Tee, L=600 mm	0,9m/m ²	-
5 Connect Adjustable Hanger, installed at 1200 mm centres (max. distance from wall 600 mm)	0,7/m ²	0,7/m ²
6 Connect Hanger Clip (not to be used in swimming hall environments)	0,7/m ²	0,7/m ²
7 Connect Universal Clip 0083	11/m ²	7/m ²
8 Alt. Connect Angle Trim, fixed c300	as required	as required
9 Alt. Connect Shadow-line Trim, fixed c300	as required	as required
10 Connect Inspection Hatch	as required	as required
11 For direct installation: Connect Direct Bracket, installed at 1200 mm centres	0,7/m ²	0,7/m ²
Δ Min. overall depth of system, with adjustable hanger and clip: 150 mm, with direct fixing without clip: 50 mm.	-	-
δ Min. demounting depth: With clip: 150 mm. Without clip: 100 mm.	-	-

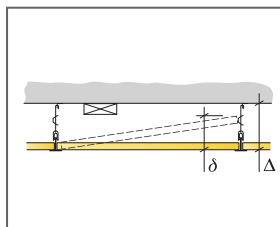

See Quantity Specification

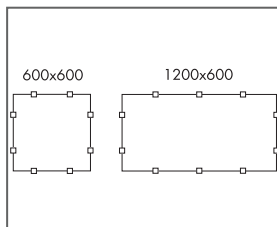

Arrangement of clips

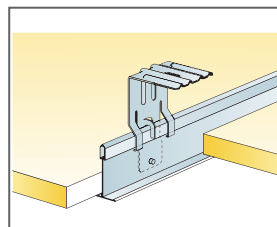

Suspension with Connect Direct Bracket

Size, mm	Max live load [N]	Min load bearing capacity [N]
600x600x15	50	160
1200x600x15	50	160

Live load/load bearing capacity