

# Ecophon Solo™ Hexagon

Solo Hexagon is a free-hanging unit, offering high level design possibilities. Three different suspension systems offer opportunities to create several layers and angles. Suitable when the room volume should be maintained or when it's not possible to install a wall-to-wall ceiling.



Chelance Arena, Belgium

## SYSTEM RANGE



Size, mm	1040x1200
Special Fixing	•
Thickness	40
Inst. Diagr.	M426

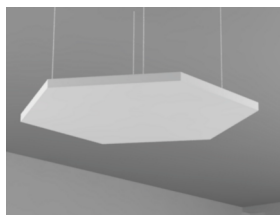

Suspension with Connect Adjustable wire hanger and Connect Absorber anchor

## Acoustic



The values in the diagram refer to a single unit. If the units are arranged in a cluster with distances between units less than 0,5 meters, the Aeq per unit will be slightly reduced.

### Sound Absorption:

Based on test results according to EN ISO 354.

A<sub>eq</sub>: Equivalent absorption area per unit (m<sup>2</sup> sabin)

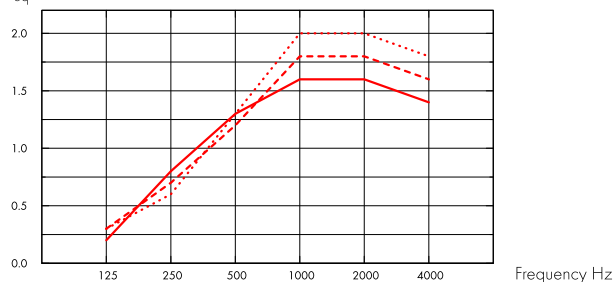

- Solo Hexagon 1040x1200, 200 mm o.d.s.
  - - - Solo Hexagon 1040x1200, 400 mm o.d.s.
  - ... Solo Hexagon 1040x1200, 1000 mm o.d.s.
- o.d.s. = overall depth of system

THK mm	o.d.s. mm	A <sub>eq</sub> : Equivalent absorption area per unit (m <sup>2</sup> sabin)					
		125 Hz	250 Hz	500 Hz	1000 Hz	2000 Hz	4000 Hz
40	200	0.2	0.8	1.3	1.6	1.6	1.4
40	400	0.3	0.7	1.2	1.8	1.8	1.6
40	1000	0.3	0.6	1.3	2.0	2.0	1.8

## Indoor Air Quality



Certificate / Label	All Products
Eurofins Indoor Air Comfort®	IAC Gold
French VOC	A+
Finnish M1	•



## Cradle to Cradle Certified®



This product is Cradle to Cradle Certified® at Bronze level (version 4.0).



## Material Health

This product has received a C2C Certified Material Health Certificate™ at the Silver level (standard version 4.0). The C2C Certified Material Health Certificate™ is a verification of the health and safety of a product's composition using the Material Health requirements of the Cradle-to-Cradle Certified Product Standard.



## Carbon footprint

	kg CO <sub>2</sub> equiv/m <sup>2</sup>
Solo Freedom	8,41
Solo Freedom/Plant	5,21

Life-cycle stages A1 to C4 from EPD, in conformity with ISO 14025 / EN 15804



## Circularity

Minimum post-consumer recycled content	57%
Recyclability	Fully recyclable



## Fire safety

Country	Fire standard	Class
Europe	EN 13501-1	A2-s1,d0

The glass wool core of the tiles is tested and classified as non-combustible according to EN ISO 1182.



## Humidity Resistance

Product	Classification
Standard	Class C, RH 95% and 30°C
Plant	Class A, RH 70% and 25°C

According to EN 13964:2014



## Visual appearance

White Frost, nearest NCS colour sample S 0500-N, 85% light reflectance. Gloss < 1.



## Cleanability

Daily dusting and vacuum cleaning. Weekly wet wiping.



## Accessibility

The tiles are demountable.



## Installation

Installed according to installation diagrams, installation guides and drawing aid. For information regarding minimum overall depth of system see quantity specification.



## System weight

	kg/m <sup>2</sup>
Solo Hexagon	4,7

Weight information is indicative and subject to variation.



## Mechanical properties

The tile can take both point loads and distributed loads. See Functional demands, Mechanical properties at [www.ecophon.com](http://www.ecophon.com).



## CE

---

Ecophon ceiling systems are CE marked according to the European harmonized standard EN13964:2014. CE marked construction products are covered by a Declaration of Performance (DOP) which enables customers and users to easily compare performance of products available on the European market.

## INSTALLATION DIAGRAM (M426) FOR ECOPHON SOLO HEXAGON

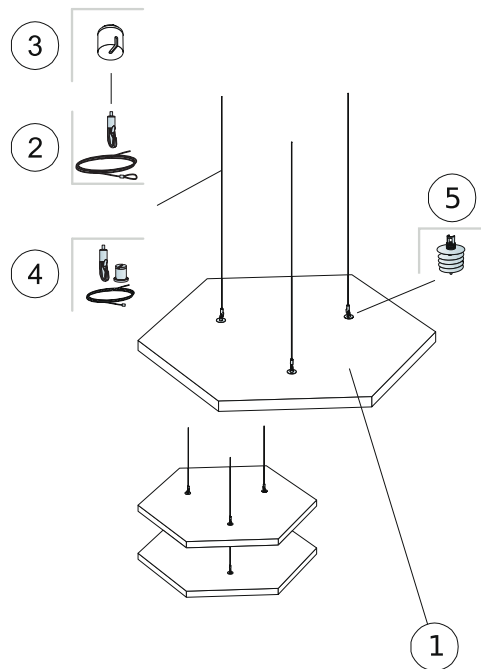

### QUANTITY SPECIFICATION (EXCL. WASTAGE)

		Size, mm
		1040x1200
1	Solo Hexagon	0,94m <sup>2</sup> /panel
2	Connect Adjustable wire hanger (Alt 1)	3/panel
3	Connect Covering cup (Alt 1, Optional)	3/panel
4	Connect Adjustable wire Kit (Alt 1, Optional)	3/panel
5	Connect Absorber anchor (Alt 1)	3/panel
Δ Min. overall depth of system: 140 mm		-
To install Connect Absorber Anchor, use Connect Absorber Anchor Bit.		-

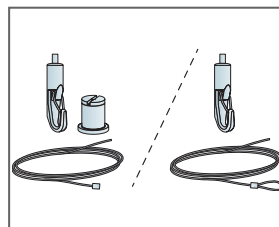
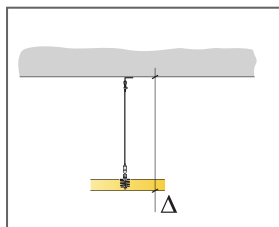

Two types of Adjustable wire solutions

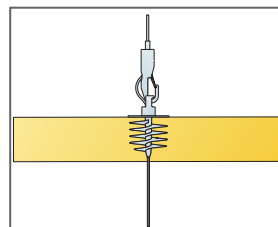

Panels can be suspended underneath each other

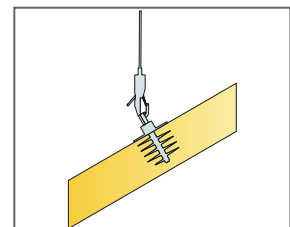

Panels can be installed in angles